

NEW

Compact & Long Range Laser Distance Sensor

HG-F1 SERIES



FDA
Conforming to
FDA regulations



Pinpoint detection from
3 m **9.843 ft** away



Compact & Long Range

Laser Distance Sensor HG-F1 Series

The laser distance sensor **HG-F1** series features a lightweight and high-strength aluminum diecast case with a built-in TOF sensor module.

Determines distance by measuring the time for the emitted beam to be reflected and return so that a single model can cover a measurement range of 250 to 3,000 mm **9.843 to 118.110 in.**



Capable of long-range sensing of up to 3 m **9.843 ft**

The sensor unit can be installed and set up anywhere so that equipment designing flexibility can be enhanced.

Distance measuring system ensures stable sensing.

The sensor measures the distance to the workpiece so that the performance is minimally affected by changes in workpiece colors or materials.

Two types of spot mode

The product employs the most suitable spot beams for distance ranging and for installation / adjustment. The emitted beam spot check mode facilitates adjustment in long-range sensing.

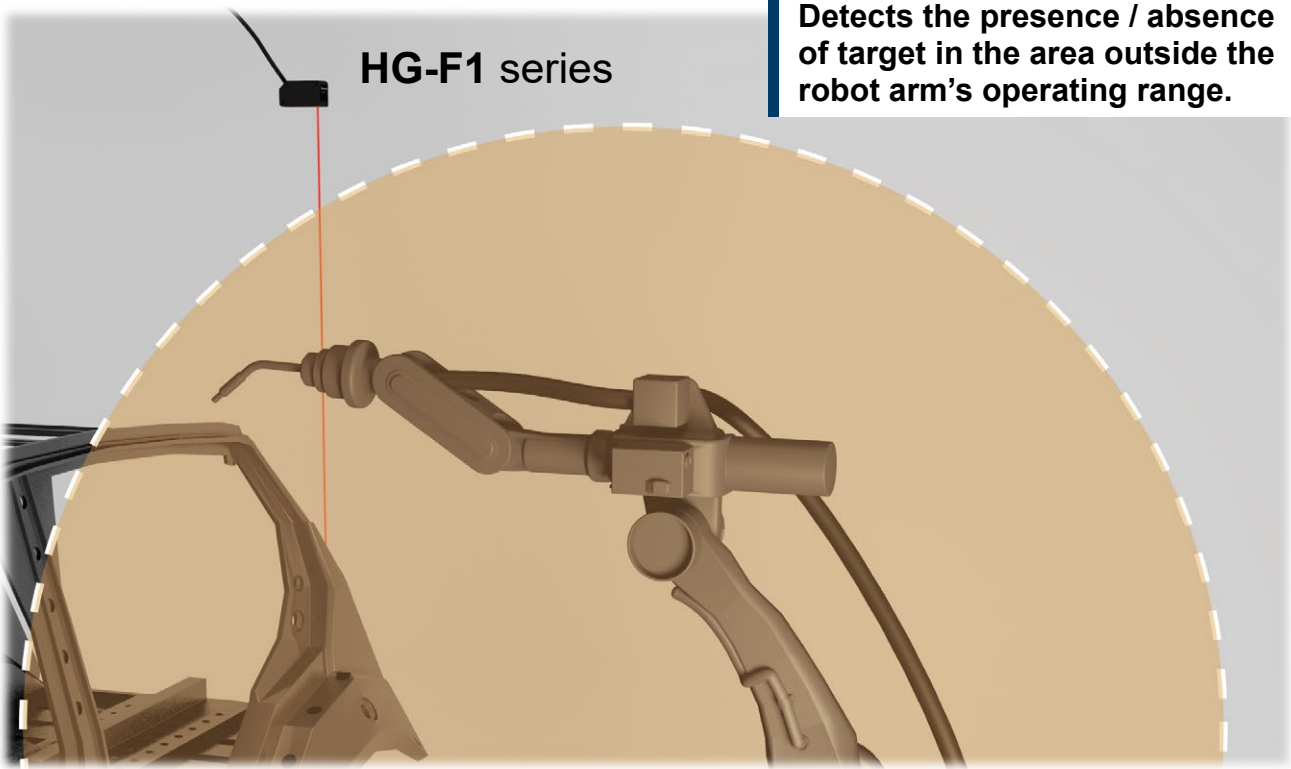

Long-range, 3-m 9.843-ft sensing capability allows installation anywhere

Sensing from positions where sensor installation does not interfere with work

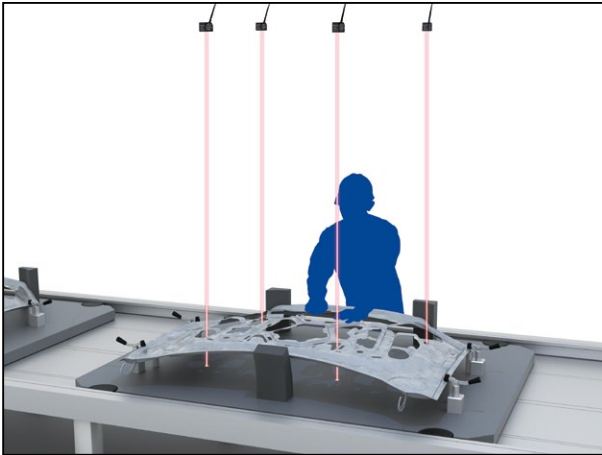

Installation at positions where sensors are not affected by scattering debris

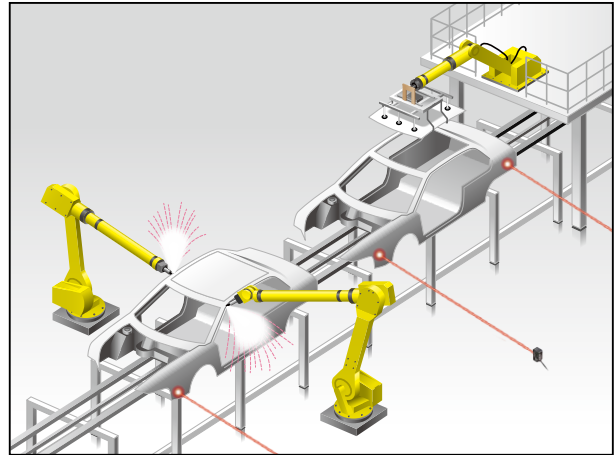

The long-distance sensing capability enables the installation of sensors at positions where they do not interfere with human workers or robot arm operation or at distant locations where the sensors will not be affected by scattering debris.

■ Comparison of product series

Product name / series name	Model No.	Measurable range / Measurement center distance and Measurement range	Beam diameter (typical value)	Repeatability
<p>NEW Compact & Long Range Laser Distance Sensor HG-F1 series</p> <p>250 mm 9.843 in 1,000 mm 39.370 in 2,000 mm 78.740 in 3,000 mm 118.110 in</p> <p>* Illustrated image of measuring distance</p>	HG-F1 □	250 to 3,000 mm 9.843 to 118.11 in	Approx. ϕ 10 mm ϕ 0.394 in at the measuring distance of 1,000 mm 39.370 in	10 mm 0.394 in or less
<p>Panasonic's CMOS type Micro Laser Distance Sensor HG-C series</p> <p>600 mm 23.622 in (HG-C1400□)</p>	HG-C1030 □	30±5 mm 1.181±0.197 in	Approx. ϕ 50 μ m ϕ 1.969 mil	10 μ m 0.394 mil
	HG-C1050 □	50±15 mm 1.969±0.591 in	Approx. ϕ 70 μ m ϕ 2.756 mil	30 μ m 1.181 mil
	HG-C1100 □	100±35 mm 3.937±1.378 in	Approx. ϕ 120 μ m ϕ 4.724 mil	70 μ m 2.756 mil
	HG-C1200 □	200±80 mm 7.874±3.150 in	Approx. ϕ 300 μ m ϕ 11.811 mil	200 μ m 7.874 mil
	HG-C1400 □	400±200 mm 15.748±7.874 in	Approx. ϕ 500 μ m ϕ 19.685 mil	300 μ m 11.811 mil (Measuring distance 200 to 400 mm) 7.874 to 15.748 in 800 μ m 31.496 mil (Measuring distance 400 to 600 mm) 15.748 to 23.622 in

* The sensing object used for the **HG-F1** series was a sheet of white non-glossy paper measuring 200 × 200 mm 7.874 in × 7.874 in and the sensing object used for the **HG-C** series was white ceramics.

* The beam diameter was defined as $1/e^2$ (approx. 13.5%) of the center light intensity. It is the size at a measuring distance of 1,000 mm 39.370 in in the case of the **HG-F1** series or at the measurement center distance in the case of the **HG-C** series.

Distance measuring system ensures stable sensing.

The product is equipped with a 7-segment display that indicates measured distances digitally in mm. Quantification of detection states enables the setting of the most suitable threshold values consistently for anyone.

Digital display of measured distance

- Measured distance is displayed in mm.



Measurement of distance to the workpiece

- Not easily affected by material or color.
- Enables the confirmation of quantity of stacked objects and detects position.

Confirmation of delivery of workpiece / quantity of stacked objects at transfer robot section

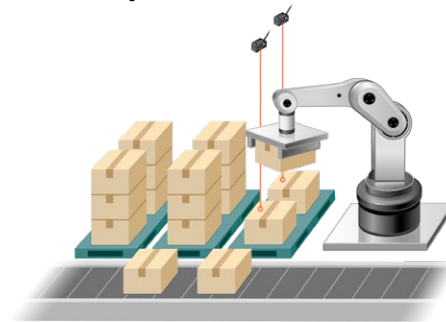

Analog output

- Measured values can be output to an external device (analog voltage: 0 to +5 V, analog current: +4 to +24 mA)
- The analog scaling setting enables the acquisition of data from a desired measurement range.

Compact and robust aluminum diecast body

The **HG-F1** series sensor has been downsized by about 80% of the previous long range distance sensor model (**EQ-500** series) by volume ratio. The unit body is made of aluminum diecast so it is lightweight and robust.

Panasonic's long range distance sensor EQ-500 series



HG-F1 series

Compact shape
20 (W) × 44 (H) × 25 (D) mm
0.787 (W) × 1.732 (H) × 0.984 (D) in

Lightweight and robust
Aluminum diecast body

High bending resistance
Standard cable

Selectable use of spot beam according to specific usage conditions

Emitted beam spot check mode

Work efficiency can be improved by selecting the most suitable spot beam type from the two options according to specific usage conditions. The spot beam emitted for measurement blends in with the surroundings to minimize the discomfort resulting from the laser that comes into the field of vision. During installation / adjustment, the emitted beam spot check mode allows clear recognition of the beam spot and enables the reliable confirmation of sensing position even in the case of long-distance sensing.

During measurement

Unobtrusive beam spot

Reduces workers' discomfort

During installation / adjustment

Emitted beam spot check mode

Increases the beam emitting power and makes the beam spot flash in 1-second intervals.

Clear confirmation of spot beam

* The beam spot appears differently depending on the detected object's material, surrounding conditions and distance.

* When the emitted beam spot check mode is used, the distance to the detected object cannot be measured.

Visible light laser (Class 1) achieves pinpoint detection

Narrow field sensing

The spot beam is smaller than that of a conventional adjustable-range distance sensor so that pinpoint detection is possible.

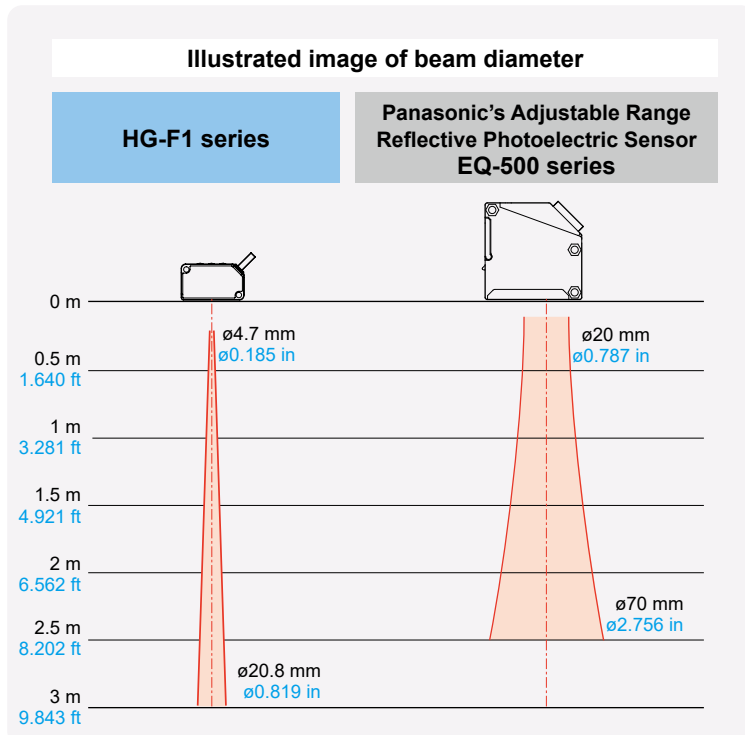

Detection through a gap is possible

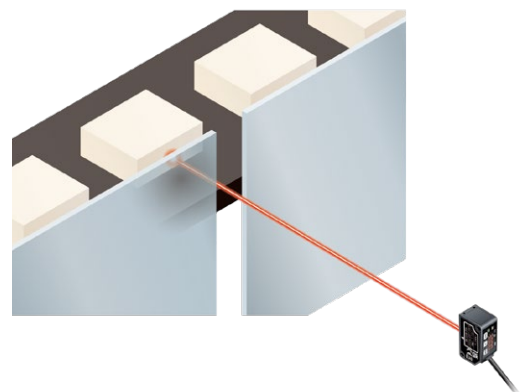

Possible to detect small workpieces

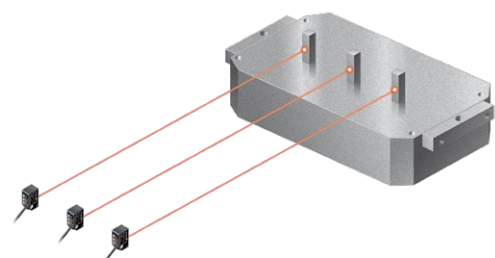

* The above beam diameters are typical values. Confirm the appropriateness of the beam diameter in actual installation condition.

* The beam diameter may be affected by the materials of surrounding objects and their distances.

* The typical beam diameter of the EQ-501 / EQ-511 is used as the diameter of the EQ-500 series.

Useful functions

Teaching function

Normal sensing mode

2-point teaching

Basic teaching method

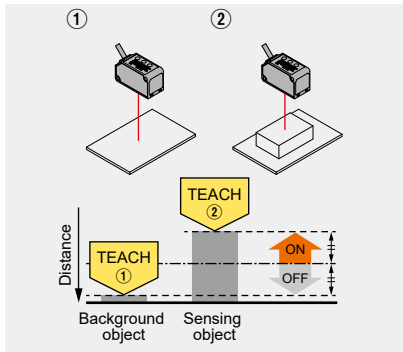

The threshold value is set automatically at the midpoint between the two points specified by teaching.

Limit teaching

Useful teaching method for when there is a very small object or background object.

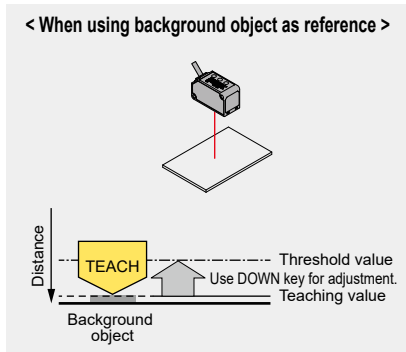

When the sensing object is located closer to the sensor than the background object, the threshold value for detection is set.

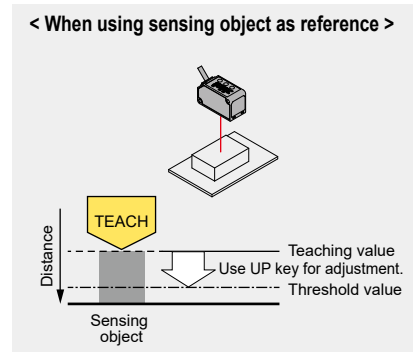

The threshold value is set on the background object side with reference to the sensing object. Use this method when there is a long distance to the background object.

Window comparator mode

With an object below the sensor, press the TEACH key to set the valid range for distances via threshold values. In addition, a single output can be used to judge whether two thresholds are within the range of "Pass" and outside the range of "Fail."

1-point teaching

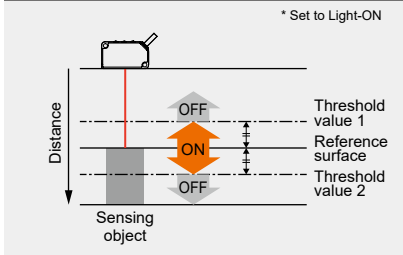

This method performs one-point teaching for the distance to the reference surface of the sensing object and sets the value obtained by subtracting the amount of shift from the result in threshold value 1 and the value obtained by adding the amount of shift to the result in threshold value 2.

2-point teaching

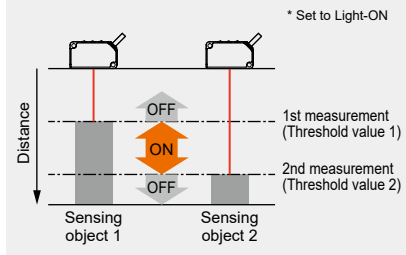

This method performs two-point teaching (sensing objects 1 and 2) for the two reference surfaces and sets the results in threshold value 1 and threshold value 2.

3-point teaching

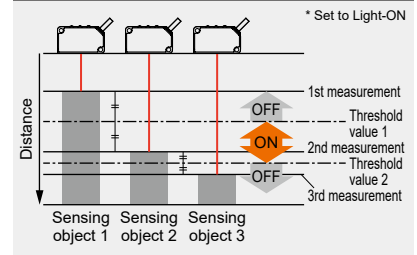

This method performs three-point teaching (sensing objects 1, 2 and 3) for the three references surfaces and sorts the teaching results in the descending order (Max, Middle, Min). Then, it sets the intermediate value between Min and Middle in threshold value 1 and sets the intermediate value between Middle and Max in threshold value 2.

Zero set function

This function compulsorily sets the measured value to "zero." The zero point can be set at a desired value. It is useful when measuring steps or tolerance with reference to the height of a sensing object.

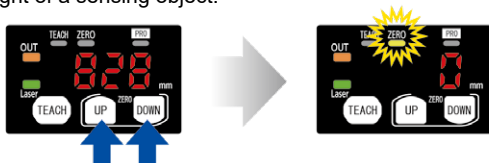

Keep pressing both keys for 3 seconds.

- * The zero set indicator (yellow) will turn ON while the zero set is valid.
- * If the zero set function is executed while the peak / bottom hold function is valid, the held measurement value will be reset and the zero set function cannot be set.
- * If the peak / bottom hold function is enabled while the zero set setting is valid, the zero set setting will be cancelled.
- * If an error occurs, the zero set function cannot be set.
- * An external input can be used to set the zero set function.

External input setting function

One of three functions, "zero set function," "teaching function" and "emission stopping function" can be assigned to an external input line.

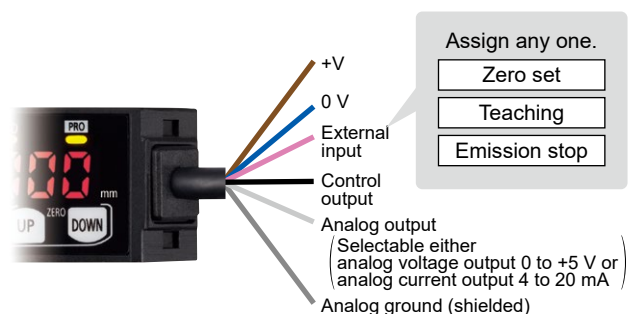

Timer setting function

The timer operation can be selected from “off delay timer”, “on delay timer”, “one-shot timer” and “no timer”.
The timer period can also be selected.*

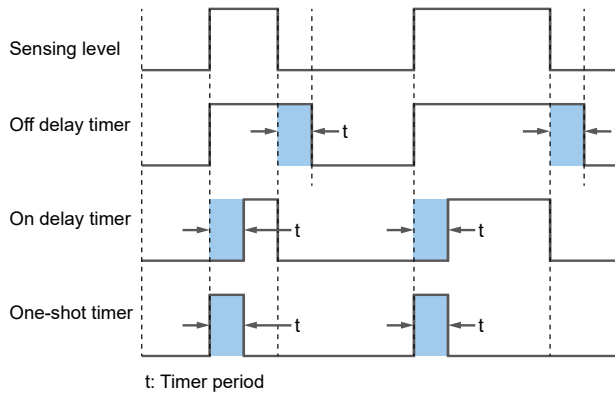

* The timer period can be selected from the following: 5 ms, 10 ms, 25 ms, 50 ms, 100 ms, 250 ms, 500 ms, 1,000 ms and 5,000 ms.

Off delay timer

< Function > Extends the signal output for the set timer period.
< Usage > Useful when the connected device is slow to respond and the ON time is required to be extended.

On delay timer

< Function > Overrides the signal output for the set timer period after the detection.
< Usage > Useful when it is necessary to override temporary signals or to provide control after a time lag.

One-shot timer

< Function > Outputs the signal for the set timer period after the detection.

< Usage > Useful when the signal duration needs to be constant due to the condition of input from the connected device. Also useful when the temporary signal needs to be extended to a certain time length.

Applications

Confirmation of door parts installation



Detection of remaining amount of sheet

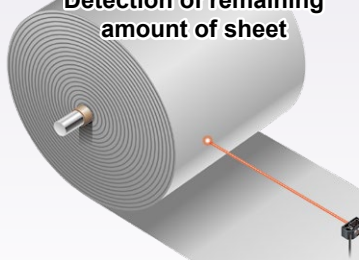

Detection of car seats

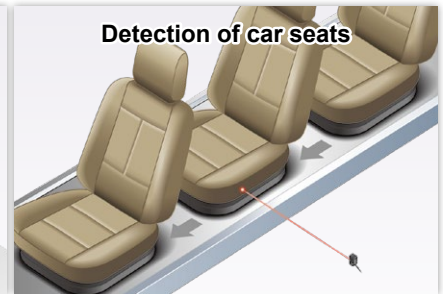

Detection of vertically stacked objects

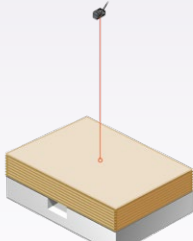

Detection of remaining amount in hopper



Confirmation of delivery of workpiece / quantity of stacked objects at transfer robot section

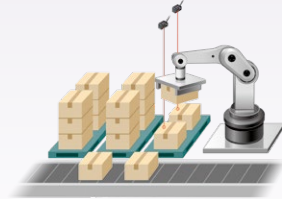

Detection from the outside of robot arm's operating range

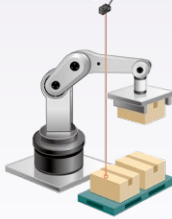

Load presence confirmation



Detection of vehicle body position

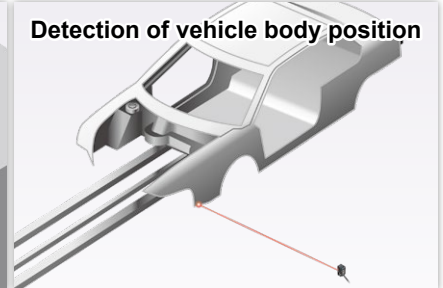

Shown above are application examples. Note that detection may not be possible in some cases due to the shapes, color, luster, etc. of the workpieces used by the customer. Be sure to confirm proper operation with actual machines. If the sensors fail to detect, consult our sales office in charge.

ORDER GUIDE

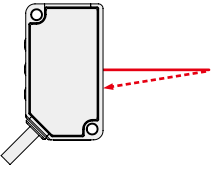
Appearance	Measurable range	Repeatability (Note 1)	Beam diameter (Note 2)	Model No.	
				NPN output	PNP output
	250 mm to 3,000 mm 9.843 in to 118.110 in	10 mm 0.394 in or less	Approx. $\phi 10$ mm $\phi 0.394$ in (typical) (at the measuring distance of 1,000 mm 39.370 in)	HG-F13A-A-N	HG-F13A-A-P

Notes: 1) Value obtained using a sheet of white non-glossy paper measuring 200 × 200 mm 7.874 × 7.874 in

2) These values were defined by using $1/e^2$ (approx. 13.5%) of the center light intensity.

Due to leak light outside the defined range, the measurement values may be affected if the reflectance around the detecting point is higher than that of the detecting point.

OPTIONS

Designation	Model No.	Description
Simple mounting bracket	MS-HG-01	Foot angled mounting bracket

Simple mounting bracket

• MS-HG-01

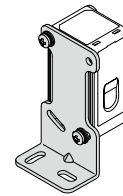

Material: Stainless steel (SUS304)

Two M3 (length 25 mm 0.984 in) screws with washers (SPCC) are attached.

WIRING DIAGRAMS

HG-F13A-A-N

NPN output type

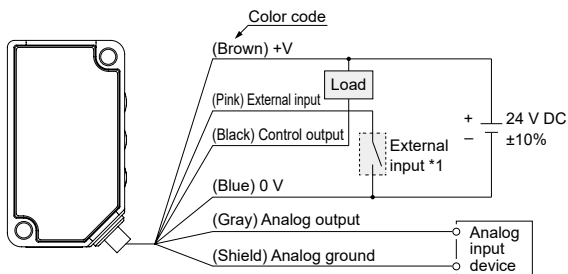

* 1

Non-voltage contact or NPN open-collector transistor

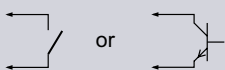

- External input
- Invalid: +8 V to +V DC or open
- Valid: 0 to +1.2 V DC

Note: Insulate the unused terminals in order to prevent input errors and short-circuits.

HG-F13A-A-P

PNP output type

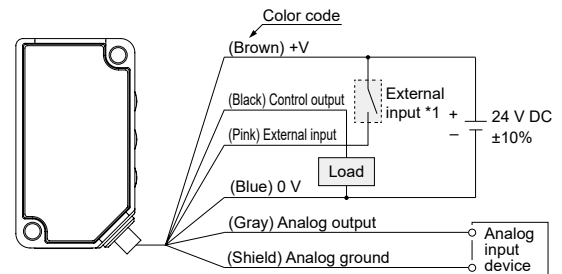

* 1

Non-voltage contact or PNP open-collector transistor

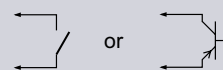

- External input
- Invalid: 0 to +0.6 V DC or open
- Valid: +4 V to +V DC

Note: Insulate the unused terminals in order to prevent input errors and short-circuits.

SPECIFICATIONS

Type		NPN output type	PNP output type
Item	Model No.	HG-F13A-A-N	HG-F13A-A-P
Applicable regulations and certifications		CE Marking (EMC Directive, RoHS Directive), UKCA Marking (EMC Regulations, RoHS Regulations), FDA Regulations, TÜV SÜD NRTL certification (USA, Canada)	
Measurable range		250 to 3,000 mm 9.843 in to 118.110 in	
Displayable range (Note 2)		200 to 3,300 mm 7.874 in to 129.921 in	
Repeatability		10 mm 0.394 in or less (target object: sheet of white non-glossy paper measuring 200 × 200 mm 7.874 × 7.874 in)	
Hysteresis		30 mm 1.181 in (default setting) Possible to vary up to 1 mm 0.039 in minimum in the PRO mode (Note 3)	
Linearity		± 2% F.S. (Note 4) (at a measuring distance of 500 mm to 3,000 mm 19.685 in to 118.110 in)	
Temperature characteristics		0.1% F.S./°C	
Light source		Red semiconductor laser: Class 1 [JIS / IEC / GB / KS / FDA (Note 5)] Maximum output: 0.39 mW, Peak emission wavelength: 680 nm 0.0268 mil	
Beam diameter (Note 6)		Approx. ø10 mm ø0.394 in (typical) (at the measuring distance of 1,000 mm 39.370 in)	
Supply voltage		24 V DC ±10%, Ripple P-P 10%	
Power consumption (Note 7)		40 mA or less (at 24 V DC supply voltage)	
Control output		NPN open-collector transistor • Maximum sink current: 50 mA • Applied voltage: 30 V DC or less (Between control output to 0 V) • Residual voltage: 1.5 V or less (At 50 mA sink current) • Leakage current: 0.1 mA or less	PNP open-collector transistor • Maximum source current: 50 mA • Applied voltage: 30 V DC or less (Between control output to +V) • Residual voltage: 1.5 V or less (At 50 mA source current) • Leakage current: 0.1 mA or less
	Output operation	Switchable between Light-ON / Dark-ON, (Default: Light-ON)	
	Short-circuit protection	Incorporated (Auto reset type)	
Analog output		Switchable between voltage output / current output (Default: voltage output)	
Analog voltage output	Output range (Note 9)	• In normal operation: 0 to +5 V Possible to set the distance range (Default: 250 to 3,000 mm 9.843 in to 118.110 in) • When alarm occurs: Last value is held or the range is set to 0 V on the near point side and to +5.2 V on the far point side.	
	Output impedance	100 Ω	
Analog current output	Output range (Note 9)	• In normal operation: +4 to +20 mA Possible to set the distance range (Default: 250 to 3,000 mm 9.843 in to 118.110 in) • When alarm occurs: Last value is held or the range is set to 0 mA on the near point side and to +20.8 mA on the far point side.	
	Output impedance	250 Ω or less	
Response time		Switchable between 35 ms / 100 ms / 300 ms / 2,000 ms (Default: 100 ms)	
External input		NPN non-contact input • Input condition Invalid: +8 to + V DC or Open Valid: 0 to +1.2 V DC • Input impedance: approx. 10 kΩ	PNP non-contact input • Input condition Invalid: 0 to +0.6 V DC or Open Valid: +4 to +V DC • Input impedance: approx. 10 kΩ
External input function		Switchable between zero set, teaching, or emission stop (Default: zero set)	
Teaching function		Switchable between normal sensing mode (2-point / limit) or window comparator mode (1-point / 2-point / 3-point) (Default: Normal sensing mode)	
Timer function		Switchable between OFF / ON delay / OFF delay / one-shot (Default: OFF)	
Timer period		Switchable between 5 ms / 10 ms / 25 ms / 50 ms / 100 ms / 250 ms / 500 ms / 1,000 ms / 5,000 ms (Default: 5 ms)	
Pollution degree		2	
Overvoltage category		Category I	
Ambient altitude (Note 8)		2,000 m 6561.680 ft or less	
Environmental resistance	Protection	IP67 (IEC)	
	Ambient temperature	-10 to +45 °C +14 to 113 °F (No dew condensation or icing allowed), Storage: -20 to +60 °C -4 to 140 °F	
	Ambient humidity	35 to 85% RH, Storage: 35 to 85% RH	
	Ambient illuminance	Incandescent light: 3,000 lx or less at the light-receiving face	
	Vibration resistance	10 to 55 Hz (period: 1 min.) frequency, 1.5 mm 0.059 in double amplitude in X, Y and Z directions for two hours each	
Shock resistance		500 m/s ² acceleration (approx. 50 G) in X, Y and Z directions three times each	
Cable		0.2 mm ² 5-core composite cable, 2 m 6.562 ft long	
Cable extension		Extension up to total 10 m 32.808 ft is possible with 0.3 mm ² , or more, cable	
Material		Enclosure: Aluminum die-cast, Front cover: Acrylic, Cable: PVC	
Weight		Net weight: approx. 85 g, Gross weight: approx. 130 g	

- Notes: 1) Unless otherwise specified, measurement conditions are as follows: Power supply voltage of 24 VDC, ambient temperature of +20 °C **+68 °F**, response time of 100 ms, and measuring distance of 1,000 mm **39.370 in**. The target object is a 200 mm × 200 mm **7.874 in × 7.874 in** white non-glossy paper. Perform measurement 30 minutes after turning on the power supply.
- 2) When an object is detected, the range of numerical values that appear on the digital display is regarded as the displayable distance. When zero setting is performed, the displayable distance varies depending on the zero setting distance.
- 3) Changing the hysteresis may result in unstable sensing. After making a change, perform operation check using actual equipment.
- 4) F.S. (full scale) represents a range from 0 mm to 3,000 mm **0 in to 118.110 in**.
- 5) This product complies with the FDA regulations (FDA 21 CFR 1040.10 and 1040.11) in accordance with FDA Laser Notice No. 56, except for complying with IEC 60825-1 Ed. 3.
- 6) The beam diameter is defined as 1/e² (approx. 13.5%) of the center light intensity. Due to leak light outside the defined range, the measurement values may be affected if the reflectance around the detecting point is higher than that of the detecting point.
- 7) Analog output is not included.
- 8) Do not use or store this product in environments where ambient air is pressurized to an air pressure higher than the atmospheric pressure at an altitude of 0 m.
- 9) When the intensity of received light is unstable, the voltage is output as 0 V and the current is output as 0 mA.

REPEATABILITY CHARACTERISTICS (TYPICAL)

* Be sure to confirm proper condition in actual installation condition.

Repeatability by sensing distance/by response time

Measuring distance	White non-glossy paper				Gray non-glossy paper			
	Response time				Response time			
	35 ms	100 ms	300 ms	2,000 ms	35 ms	100 ms	300 ms	2,000 ms
250 mm 9.843 in	5 mm 0.197 in	5 mm 0.197 in	3 mm 0.118 in	1 mm 0.039 in	6 mm 0.236 in	6 mm 0.236 in	3 mm 0.118 in	1 mm 0.039 in
500 mm 19.685 in	6 mm 0.236 in	5 mm 0.197 in	3 mm 0.118 in	1 mm 0.039 in	6 mm 0.236 in	7 mm 0.276 in	3 mm 0.118 in	1 mm 0.039 in
1,000 mm 39.370 in	7 mm 0.276 in	6 mm 0.236 in	3 mm 0.118 in	2 mm 0.079 in	7 mm 0.276 in	7 mm 0.276 in	5 mm 0.197 in	2 mm 0.079 in
2,000 mm 78.740 in	7 mm 0.276 in	6 mm 0.236 in	3 mm 0.118 in	3 mm 0.118 in	14 mm 0.551 in	7 mm 0.276 in	5 mm 0.197 in	3 mm 0.118 in
3,000 mm 118.110 in	7 mm 0.276 in	6 mm 0.236 in	4 mm 0.157 in	3 mm 0.118 in	23 mm 0.906 in	12 mm 0.472 in	9 mm 0.354 in	4 mm 0.157 in

* The above values were obtained using a sheet of white non-glossy paper measuring 200 × 200 mm 7.874 × 7.874 in (N9 to N9.5, reflectance: approx. 80%) or a sheet of gray non-glossy paper measuring 200 × 200 mm 7.874 × 7.874 in (N5, reflectance: approx. 20%).

SENSING CHARACTERISTICS (TYPICAL)

* Be sure to confirm proper condition in actual installation condition.

Emitted beam characteristics

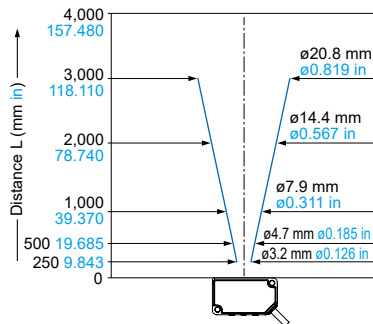

Correlation between material and sensing distance

• Setting distance: 1,000 mm 39.370 in

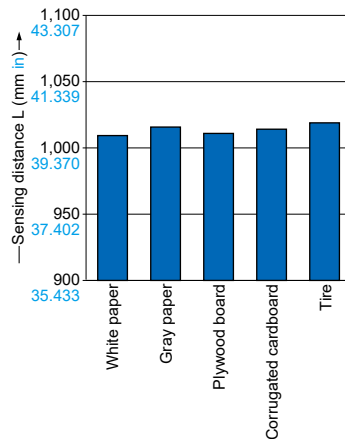

• Setting distance: 2,500 mm 98.425 in

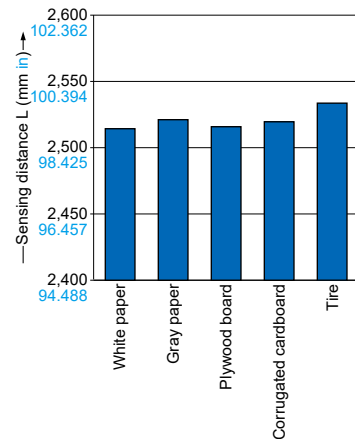

PRECAUTIONS FOR PROPER USE

• This catalog is a guide to select a suitable product. Be sure to read instruction manual attached to the product prior to its use.



- Never use this product as a sensing device for personnel protection.
- In case of using sensing devices for personnel protection, use products which meet laws and standards, such as OSHA, ANSI or IEC etc., for personnel protection applicable in each region or country.



- If the product is controlled or adjusted using a procedure other than the one specified in the instruction manual or user's manual, exposure to the hazardous laser radiation may result.



- This product is classified as a Class-1 laser product under the IEC / JIS / GB / KS standards and FDA regulations*. Do not look at the laser beam through an optical observation system such as a lens since doing so is very dangerous.
- The following label is affixed on the side of the product as per the safety regulation for laser products.

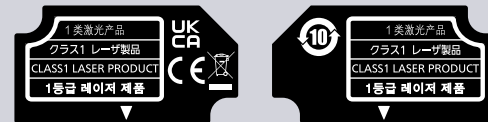

* This product complies with the FDA regulations (FDA 21 CFR 1040.10 and 1040.11) in accordance with Laser Notice No. 56 of the FDA regulations, except for the conformity with IEC 60825-1 Ed. 3.

Part description

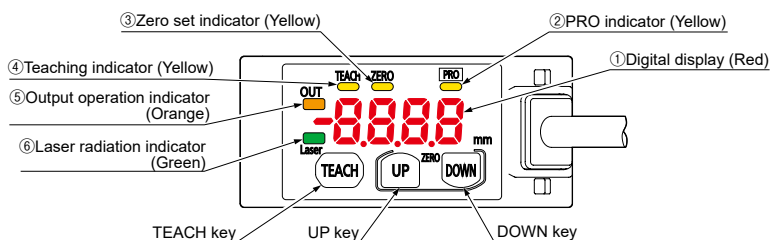
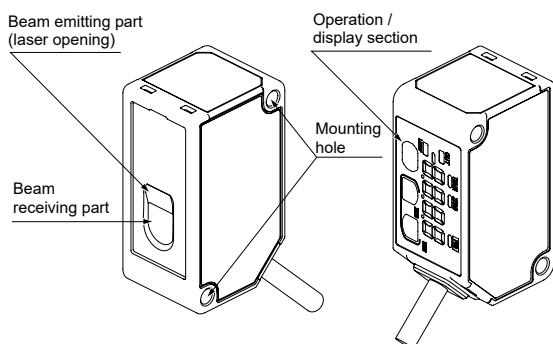

No.	Name	Function
①	Digital display (Red)	Displays measured values and settings.
②	PRO indicator (Yellow)	Lit when PRO mode is set.
③	Zero set indicator (Yellow)	Lit while the zero set function is ON.
④	Teaching indicator (Yellow)	Lit while teaching is in progress
⑤	Output operation indicator (Orange)	Lit while control output is ON.
⑥	Laser radiation indicator (Green)	Lit while laser beams are being emitted.

Emitted beam spot check method

- The emitted beam spot check mode is available to facilitate the confirmation of the laser beam spot position. When this mode is used, the beam spot becomes brighter and flashes. Activate the emitted beam spot check mode by following the procedure described below and adjust the workpiece position.

- ① After turning ON the power, make sure that the display shows the following measurement screen. Then, press and hold the UP key for 3 seconds or longer. The emitted beam spot check mode will be activated.

< Measurement screen >



Hold down for 3 seconds.

< Emitted beam spot check mode screen >

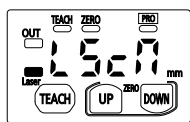

- ② The product emits a spot beam in 1-second intervals. While observing the beam spot, move the sensor unit and adjust the optical axis.

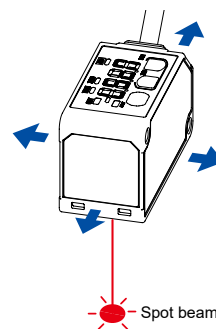

- When the "emitted beam spot check mode" is used, sensing objects cannot be measured.
- By holding down the UP key for 3 seconds or longer while the "emitted beam spot check mode" is selected, you can return to the measurement display.
- The display automatically returns to the measurement display when 2 minutes elapse after the sensor is set to the "emitted beam spot check mode". To continue to adjust the beam axis, hold down the UP key for 3 seconds or longer again to set the "emitted beam spot check mode".

PRECAUTIONS FOR PROPER USE

Installation

- When mounting the sensor unit, use M3 screws with washers (length: 25 mm 0.984 in or longer) (not included with the product). The tightening torque should not exceed 0.5 N·m.

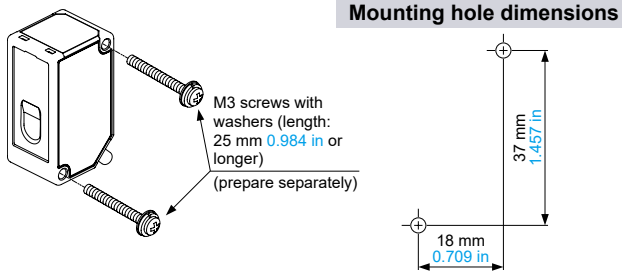

- When using multiple sensors, mount them so that emitted laser beams do not directly enter the beam receiving parts of other sensors in order to avoid mutual interference. Also, mount them so that spot beams irradiated on a workpiece do not overlap with those of other sensors.
- Do not mount the sensors closely side by side to prevent heat generation. Otherwise, the product temperature may exceed the specified temperature due to heat generation.
- To prevent the product from falling due to loose screws, take prevention measures such as using screws with washers depending on the operating environment.

- Use the tightening torque of 0.5 N·m or less when using the simple mounting bracket **MS-HG-01** (optional).

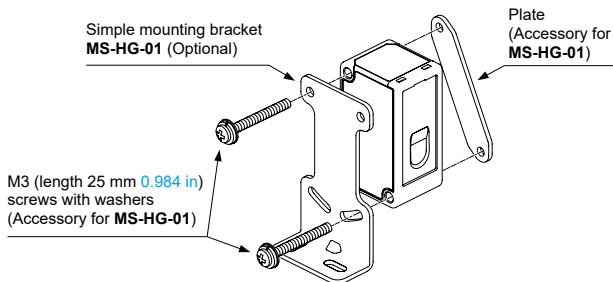

Power supply

- Verify that the supply voltage fluctuations are within the rating when using the product. Note that applying a voltage greater than the rated voltage or directly applying AC power will result in damage or burning.
- To ensure performance, use the product at least 30 minutes (warm-up time) after the power is turned ON.
- If power is supplied from a commercial switching regulator, ensure that the frame ground (F.G.) terminal of the power supply is connected to an actual ground.
- Make sure that the power supply input satisfies the following items.
 - The power supply unit must be certified for use in your region
 - The output holding time of the power supply unit must be 20 ms or more
 - The rated output voltage and ripple (P-P) of the power supply unit must be 24 V DC $\pm 10\%$ and 10% or lower, respectively.
 - The power supply unit with SELV (Safety Extra Low Voltage) or PELV (Protective Extra Low Voltage) that comply with the EMC Directive must be used (if the CE marking compliance is required).
 - The power supply unit with SELV (Safety Extra Low Voltage) or PELV (Protective Extra Low Voltage) that comply with the EMC Regulations must be used (if the UKCA marking compliance is required).
 - The power supply unit must support Class 2 (if cTUVus marking compliance is required).
- If surges occur, take countermeasures such as connecting a surge absorber to the source of the surges.
- Do not turn OFF the power while conducting teaching or saving settings such as the PRO mode setting. Doing so can damage the internal memory of the product and may disable the product from restarting.

Wiring

- Before wiring work, always turn the power OFF.
- Do not wire in parallel with a high-voltage line or power line, or run through the same conduit. Doing so may result in malfunctioning due to induction.
- Apply a load so that a current of 50 mA or more does not flow through the control output line. Also avoid incorrect wiring such as polarity connection error of the power supply. Failure to do so may cause damage or burning.
- The overall length of the cable can be extended to 10 m 32.808 ft maximum with a cable size of 0.3 mm² or more. Use a shielded cable to extend the analog wire line.
- Do not apply stress such as excessive bending or pulling to the extracted part of a cable.

Operating environment

- This product is suitable for indoor use only.
- Do not install the sensor in the following locations.
 - Locations subject to flammable gas, corrosive gas, or excessive dust
 - Locations subject to dust, metal particles, or saline matter
 - Atmospheres containing benzene, paint thinner, alcohol, or other organic solvents or strong alkaline substances such as ammonia or caustic soda
 - Locations subject to severe vibration or shock
 - Locations subject to direct sunlight
 - Locations subject to water, oil, or chemicals
 - Locations where load is applied to the sensor
- Avoid using this product in environments where condensation occurs due to sudden temperature change.
- Performance may not be satisfactory in a strong electromagnetic field.
- Although it depends on the product type, lights from rapid start type or high frequency lighting type fluorescent lamps, sunlight, etc. may affect the sensing performance. Do not allow those lights to directly enter the emitting / receiving surfaces of the product.
- Keep the light emitting and receiving windows of this product clean and free of water, oil, fingerprints, and other substances that refract light as well as dust, grit, and other objects that intercept light. When cleaning the surfaces, wipe them with a lint-free soft cloth or lens cleaning paper.
- Make sure to turn OFF the power supply before cleaning the light emitting and receiving windows of this product.
- This product is a precision device. Do not drop or otherwise subject to shock. Doing so may cause product failure.
- Due to the detection principle, if there is a background object in a specific region, a distance different from the actual distance may be displayed. Confirm actual operations in an actual operating environment.

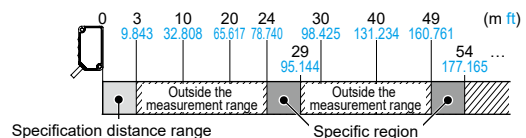

If an object exists in a particular zone, shield the laser within 24 m 78.740 ft.

Others

- This product has been developed / produced for industrial use only.
- Do not use this product outside the scope of the specifications. Doing so may result in accidents or failures. It will also significantly shorten the service life.
- There is a certain deviation in the directivity of this product. When using this product, install the product using a mounting bracket or similar fitting to allow the adjustment of beam axis.
- The internal memory (non-volatile memory) of this product has a service life. Settings cannot be configured more than one million times.
- Due to leak light around the detection point, the measurement values may be affected if there exist objects with high reflectance around the detecting point.
- If specular reflection light enters the beam receiving part, proper measurement may not be possible. When the reflectance of a detection object is high, be careful in installation.
- When exporting this product to the US, affix the provided FDA certificate / identification label near the end of the cable.
- When this product becomes unusable or unnecessary, dispose of the product properly as industrial waste in accordance with the applicable law in the country.





PRECAUTIONS FOR PROPER USE

List of Setting Items

- The following items can be set in the product.
For the method of setting each item, refer to the User's Manual for **HG-F1 Series**.
- * The User's Manual can be downloaded from our website.

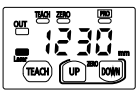
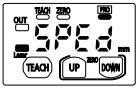
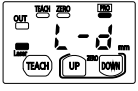
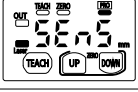
Item	Description
Emitted beam spot check mode	Enables easy confirmation of the position of the laser beam spot on the workpiece.
Teaching	Enables the setting of the threshold value. The sensing output setting in the PRO mode enables the selection of teaching method.
Peak / bottom hold function	Displays and outputs the peak value or bottom value during a certain time period.
Zero set function	Forcibly sets the current measured value to "zero" (reference value).
Key lock function	Disables key operations.

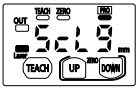
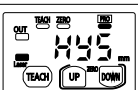
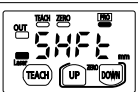
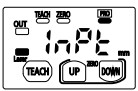
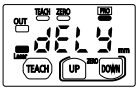
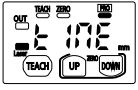
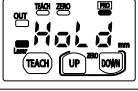
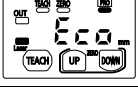
<Pro mode settings>

No.	Setting item	Display screen	Description
-	Measurement display		—
1	Response time setting		Used to set the time from when the sensor starts measurement until a measurement value is finalized and output. <Default: 100>
2	Output operation setting		Used to set the operation mode of control output. <Default: L-on>
3	Sensing output setting (teaching)		Used to set the threshold teaching method. <Default: . . f ~ >
4	Analog output setting		Used to select analog output as either analog voltage output or analog current output. <Default: Analog v.oUt>
5	Analog scaling setting		Used to set optional two points as the upper limit value and the lower limit value for performing twopoint correction on the analog output before data is output. Set the measured value A as the lower limit value and the measured value B as the upper limit value. <Measured value A default: 0, measured value B default: 3,000>
6	Hysteresis setting		Used to set the hysteresis value. <Default: 30>
7	Shift amount setting		Used to set the threshold value for limit teaching and 1-point teaching. <Default: 60>
8	External input setting		Used to set either the zero setting, teaching, or emission stop function. <Default: 0SEt>
9	Timer setting		Used to set whether to use the timer setting of control output. <Default: non>
10	Timer period setting		Used to set the timer period when "OFF delay timer, ON delay timer, or One-shot timer" is set in the timer setting. <Default: 5>
11	Hold setting		Used to set the digital display, the control output and analog output operation when a measurement error occurs (insufficient light intensity, saturation of light intensity, out of measurement range). <Default: oFF>
12	ECO setting		Used to turn OFF the digital display to save electricity when not operating. <Default: oFF>
13	Reset setting		Used to reset all the settings of this product to the factory default settings. <Default: no>

PRECAUTIONS FOR PROPER USE

Error indication

- In case of an error, try the following remedy.

Error code	Description	Remedy
Er01	Internal memory is abnormal, damaged, or has passed its life expectancy.	<ul style="list-style-type: none"> • Switch the power OFF and then ON, and select and execute the reset setting (initialization of this product) from setting items. • If the sensor does not recover after the above action, consult your Panasonic representative.
Er11	Control output load has shortcircuited and excessive current is flowing.	Turn OFF the power and check the load.
Er31	During zero setting, the measurement is not performed properly.	Check if the sensing distance to be set is within the specification range.
Er41	During teaching, the measurement is not performed properly.	Check if the sensing distance to be set is within the specification range.
Er51	The beam emitting part or the beam receiving part is abnormal.	Turn the power OFF and then ON. If the sensor does not recover after the above action, consult your Panasonic representative.
Er90, Er91, Er92, Er93, Er94, Er95, Er96	System error	The product could be faulty. Please consult your Panasonic representative.

Main Inspection Items

- Inspect the sensor regularly to maintain performance and enable optimum use. The main inspection items are as follows:
 - Is the product installation loose?
 - Have any input and output terminals become loose or come off?
 - Are there cracks in the cable?
 - Is the spot beam deviated from the set position?
 - Is the supplied power within the rated voltage range (24 V DC $\pm 10\%$)?
 - Is the ambient temperature within the specified range (-10 to +45 °C +14 to +113 °F)?
 - Is the ambient humidity within the specified range (35 to 85% RH)?
 - Are the light emitting and receiving windows of the sensor contaminated with dirt or foreign matter?

DIMENSIONS (Unit: mm in)

HG-F13A-A-N HG-F13A-A-P

Sensor

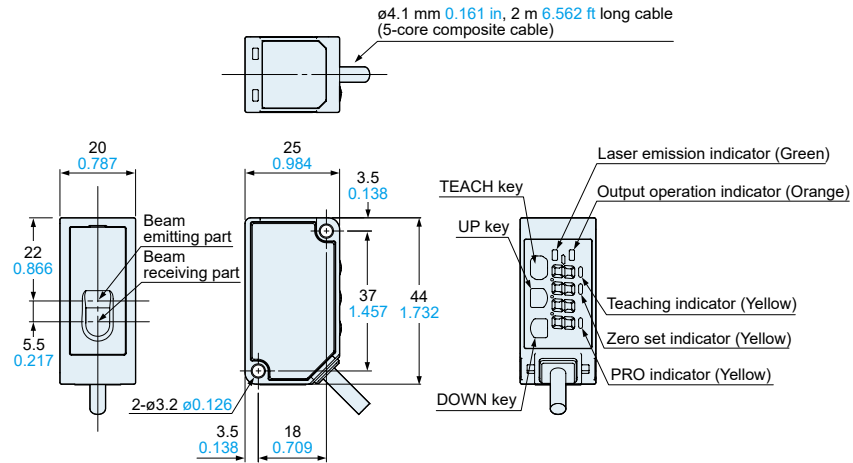

MS-HG-01

Simple mounting bracket (Optional)

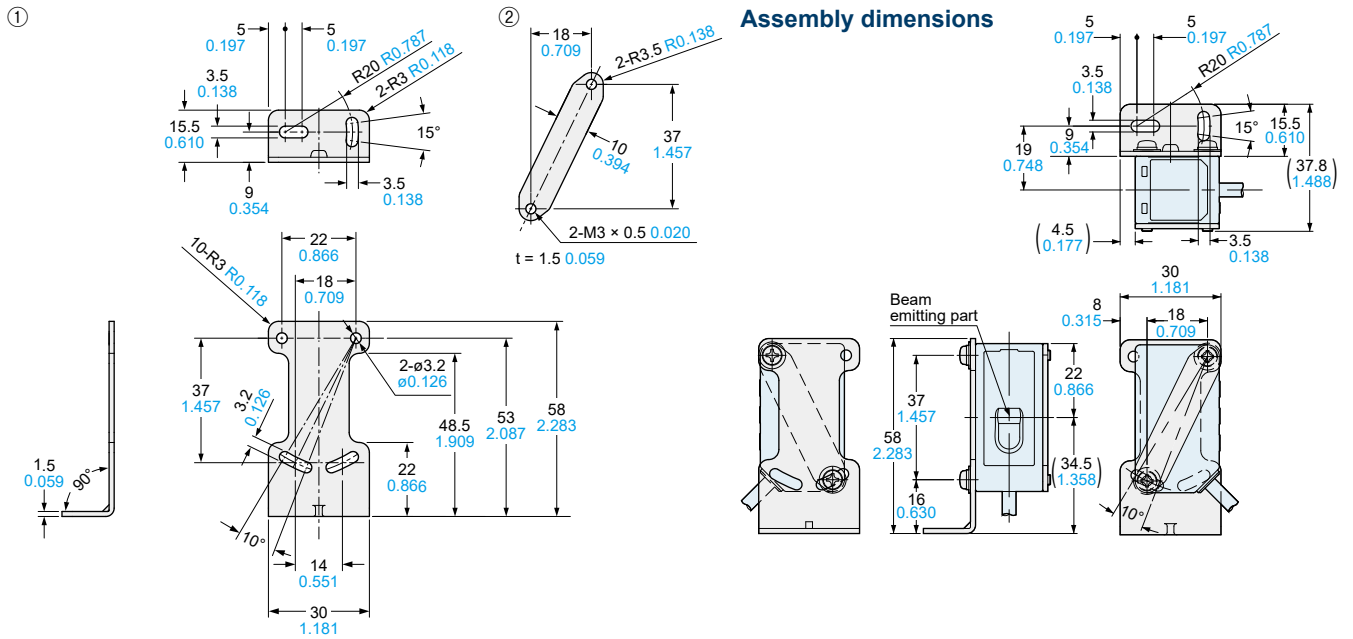

Material: Stainless steel (SUS304)
 Two M3 (length 25 mm 0.984 in) screws with washers (SPCC) are attached.

Disclaimer

The applications described in the catalog are all intended for examples only. The purchase of our products described in the catalog shall not be regarded as granting of a license to use our products in the described applications. We do NOT warrant that we have obtained some intellectual properties, such as patent rights, with respect to such applications, or that the described applications may not infringe any intellectual property rights, such as patent rights, of a third party.

Panasonic
INDUSTRY

Panasonic Industry Co., Ltd.

Industrial Device Business Division
7-1-1, Morofuku, Daito-shi, Osaka 574-0044, Japan
industrial.panasonic.com/ac/e/