



P-DUKE POWER

PDL09 Series

DC-DC Converter
Up to 9 Watts

3
YEARS
WARRANTY

ROHS
COMPLIANT

REACH
COMPLIANT

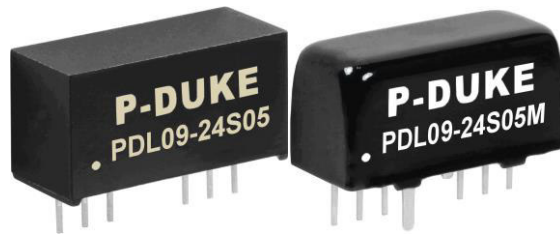

Automation



Datacom



IPC



Industry



Measurement



Telecom



Automobile



Boat



Charger



Medical



PV



Railway



1600
VDC
Isolation
Voltage

2 : 1
Input
Range

LOW
Standby
Power

NO
Min. Load
Required

REMOTE
ON
OFF

OCP

SCP

PART NUMBER STRUCTURE

PDL09 -	48	S	05	M
Series Name	Input Voltage (VDC)	Output Quantity	Output Voltage (VDC)	Case Options
	12: 9~18 24: 18~36 48: 36~75	S: Single D: Dual	3P3: 3.3 05: 5 09: 9 12: 12 15: 15 24: 24 05: ±5 12: ±12 15: ±15	M: Standard type Metal case □: Plastic case

TECHNICAL SPECIFICATION All specifications are typical at nominal input, full load and 25°C unless otherwise noted

Model Number	Input Range	Output Voltage	Output Current @ Full Load	Input Current @ No Load	Efficiency	Maximum Capacitor Load
	VDC	VDC	mA	mA	%	μF
PDL09-12S3P3M	9 ~ 18	3.3	2000	7	81	2600
PDL09-12S05M	9 ~ 18	5	1600	7	85	1300
PDL09-12S09M	9 ~ 18	9	1000	10	87	800
PDL09-12S12M	9 ~ 18	12	750	10	88	560
PDL09-12S15M	9 ~ 18	15	600	10	89	560
PDL09-12S24M	9 ~ 18	24	375	13	89	200
PDL09-12D05M	9 ~ 18	±5	±800	13	85	±800
PDL09-12D12M	9 ~ 18	±12	±375	13	88	±390
PDL09-12D15M	9 ~ 18	±15	±300	14	89	±200
PDL09-24S3P3M	18 ~ 36	3.3	2000	5	82	2600
PDL09-24S05M	18 ~ 36	5	1600	5	85	1300
PDL09-24S09M	18 ~ 36	9	1000	5	88	800
PDL09-24S12M	18 ~ 36	12	750	5	89	560
PDL09-24S15M	18 ~ 36	15	600	5	90	560
PDL09-24S24M	18 ~ 36	24	375	7	90	200
PDL09-24D05M	18 ~ 36	±5	±800	7	86	±800
PDL09-24D12M	18 ~ 36	±12	±375	7	89	±390
PDL09-24D15M	18 ~ 36	±15	±300	10	87	±200
PDL09-48S3P3M	36 ~ 75	3.3	2000	3	82	2600
PDL09-48S05M	36 ~ 75	5	1600	3	85	1300
PDL09-48S09M	36 ~ 75	9	1000	3	88	800
PDL09-48S12M	36 ~ 75	12	750	3	89	560
PDL09-48S15M	36 ~ 75	15	600	3	89	560
PDL09-48S24M	36 ~ 75	24	375	3	89	200
PDL09-48D05M	36 ~ 75	±5	±800	3	86	±800
PDL09-48D12M	36 ~ 75	±12	±375	3	87	±390
PDL09-48D15M	36 ~ 75	±15	±300	4	87	±200

INPUT SPECIFICATIONS

Parameter	Conditions	Min.	Typ.	Max.	Unit
Operating input voltage range	12Vin(nom)	9	12	18	VDC
	24Vin(nom)	18	24	36	
	48Vin(nom)	36	48	75	
Start up time	Constant resistive load	Power up	50		ms
		Remote ON/OFF	50		
Input surge voltage	1 second, max.	12Vin(nom)		36	VDC
		24Vin(nom)		50	
		48Vin(nom)		100	
Input filter			Capacitor type		
Remote ON/OFF	Referred to -Vin pin	DC-DC ON		Open or 0 ~ 0.5VDC	
		DC-DC OFF	0.5	3 ~ 12VDC	2.5
		Input current of Ctrl pin			mA
		Remote off input current	2.5		mA

OUTPUT SPECIFICATIONS

Parameter	Conditions	Min.	Typ.	Max.	Unit
Voltage accuracy		-1.0		+1.0	%
Line regulation	Low Line to High Line at Full Load	-0.2		+0.2	%
Load regulation	No Load to Full Load	Single		+1.0	%
		Dual		+1.0	
Cross regulation	Asymmetrical load 25%/100% FL	-5.0		+5.0	%
Ripple and noise	20MHz bandwidth		50		mVp-p
	With a 1 μ F/50V X7R MLCC		75		
Temperature coefficient		-0.02		+0.02	%/°C
Transient response recovery time	25% load step change		250		μ s
Over load protection	% of Iout rated; Hiccup mode		180		%
Short circuit protection		Continuous, automatic recovery			

GENERAL SPECIFICATIONS

Parameter	Conditions	Min.	Typ.	Max.	Unit
Isolation voltage	1 minute	1600			VDC
	Input to Output	1600			
	Input (Output) to Case	1000			
Isolation resistance	500VDC	1			G Ω
Isolation capacitance				50	pF
				50	
Switching frequency			400		kHz
			500		
Safety approvals	IEC/ EN/ UL62368-1			UL:E193009 CB:UL(Demko)	
Case material				Copper Non-conductive black plastic	
Base material				None	
Potting material				Silicone (UL94 V-0)	
Weight				5.9g (0.21oz)	
				4.8g (0.17oz)	
MTBF	MIL-HDBK-217F, Full load			2.939 x 10 ⁶ hrs	
				2.696 x 10 ⁶ hrs	

ENVIRONMENTAL SPECIFICATIONS

Parameter	Conditions	Min.	Typ.	Max.	Unit
Operating ambient temperature	With derating	-40		+100	°C
Maximum case temperature				100	°C
Storage temperature range		-55		+125	°C
Thermal shock				MIL-STD-810F	
Vibration				MIL-STD-810F	
Relative humidity				5% to 95% RH	

EMC SPECIFICATIONS			
Parameter	Conditions		Level
EMI	EN55032	With external components	Class A · Class B
EMS	EN55035		
ESD	EN61000-4-2	Air \pm 8kV and Contact \pm 6kV	Perf. Criteria A
Radiated immunity	EN61000-4-3	20 V/m	Perf. Criteria A
Fast transient	EN61000-4-4	\pm 2kV	Perf. Criteria A
	PDL09-12□□□ PDL09-24□□□	With an aluminum electrolytic capacitor (Nippon chemi-con KY series, 220 μ F/100V) and a TVS (SMDJ70A, 70V, 3000Watt peak pulse power) in parallel.	
	PDL09-48□□□	With an aluminum electrolytic capacitor (Nippon chemi-con KY series, 220 μ F/100V) and a TVS (SMDJ120A, 120V, 3000Watt peak pulse power) in parallel.	
Surge	EN61000-4-5	\pm 2kV	Perf. Criteria A
	PDL09-12□□□ PDL09-24□□□	With an aluminum electrolytic capacitor (Nippon chemi-con KY series, 220 μ F/100V) and a TVS (SMDJ70A, 70V, 3000Watt peak pulse power) in parallel.	
	PDL09-48□□□	With an aluminum electrolytic capacitor (Nippon chemi-con KY series, 220 μ F/100V) and a TVS (SMDJ120A, 120V, 3000Watt peak pulse power) in parallel.	
Conducted immunity	EN61000-4-6	10 Vr.m.s	Perf. Criteria A
Power frequency magnetic field	EN61000-4-8	100A/m continuous; 1000A/m 1 second	Perf. Criteria A

CAUTION: This power module is not internally fused. An input line fuse must always be used.

CHARACTERISTIC CURVE

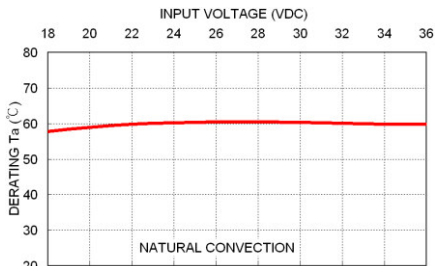

PDL09-24S12 Derating Ta v.s. Input Voltage (at Full Load)

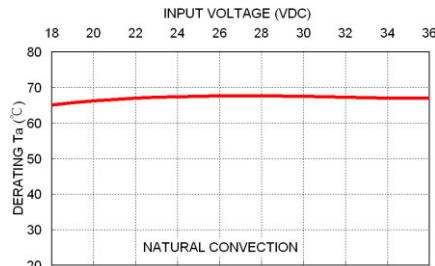

PDL09-24S12M Derating Ta v.s. Input Voltage (at Full Load)

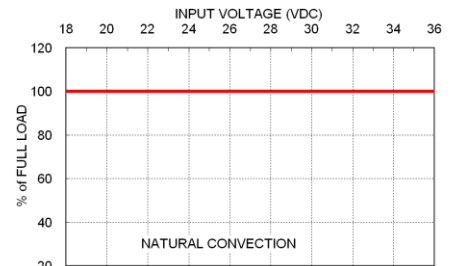

PDL09-24S12 Load Derating v.s. Input Voltage (at Ta=55°C)

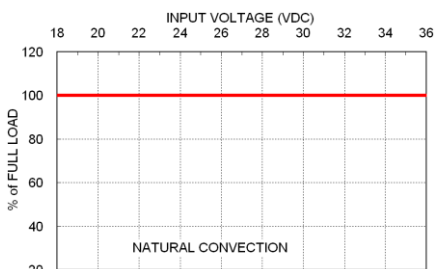

PDL09-24S12M Load Derating v.s. Input Voltage (at Ta=60°C)

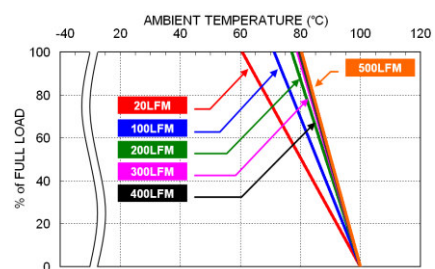

PDL09-24S12 Derating Curve

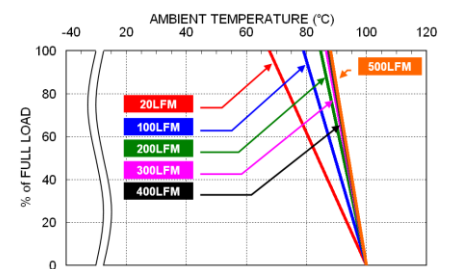

PDL09-24S12M Derating Curve

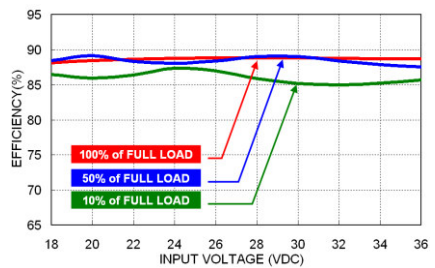

PDL09-24S12 Efficiency vs. Input Voltage

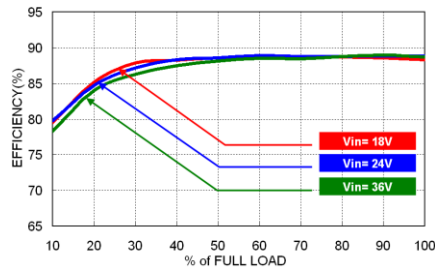

PDL09-24S12 Efficiency vs. Output Load

FUSE CONSIDERATION

This power module is not internally fused. An input line fuse must always be used.

This encapsulated power module can be used in a wide variety of applications, ranging from simple stand-alone operation to an integrated part of sophisticated power architecture.

To maximum flexibility, internal fusing is not included; however, to achieve maximum safety and system protection, always use an input line fuse.

The input line fuse suggest as below :

Model	Fuse Rating (A)	Fuse Type
PDL09-12S□□、PDL09-12D□□	3.15	Slow-Blow
PDL09-24S□□、PDL09-24D□□	2.5	Slow-Blow
PDL09-48S□□、PDL09-48D□□	1.25	Slow-Blow

The table based on the information provided in this data sheet on inrush energy and maximum DC input current at low Vin.

MECHANICAL DRAWING

Standard type Metal Case

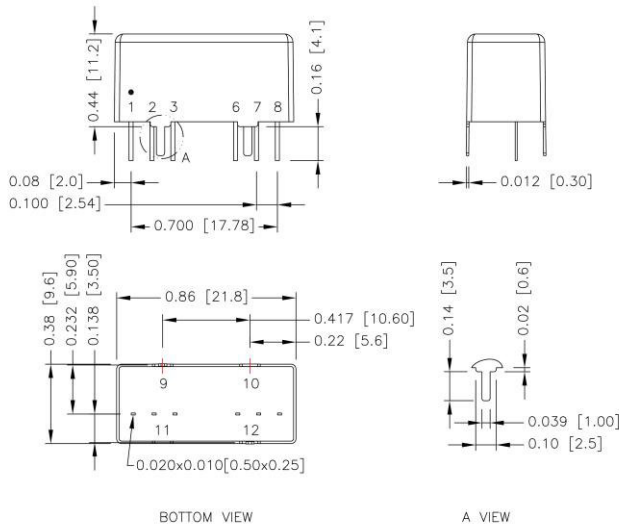

* Case pins should not be connected to any circuit.

Plastic Case

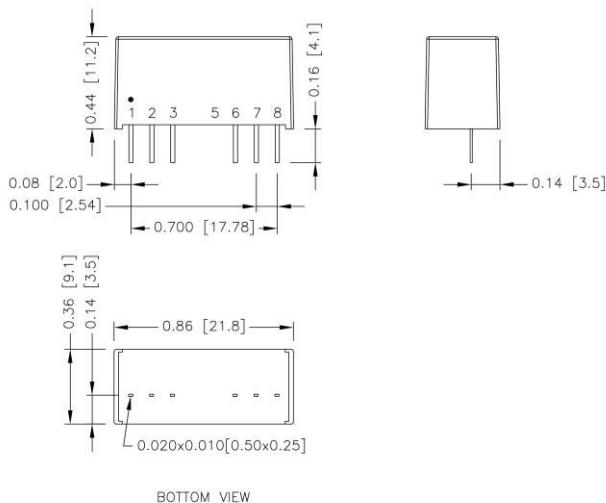

PIN CONNECTION

PIN	SINGLE	DUAL
1	-Vin	-Vin
2	+Vin	+Vin
3	Ctrl	Ctrl
6	+Vout	+Vout
7	-Vout	Common
8	NC	-Vout
9	Case	Case
10	Stand off	Stand off
11	Stand off	Stand off
12	Case	Case

1. All dimensions in inch [mm]
2. Tolerance :x.xx±0.02 [x.x±0.5]
x.xxx±0.01 [x.xx±0.25]
3. Pin dimension tolerance ±0.004[0.10]

PIN CONNECTION

PIN	SINGLE	DUAL
1	-Vin	-Vin
2	+Vin	+Vin
3	Ctrl	Ctrl
6	+Vout	+Vout
7	-Vout	Common
8	NC	-Vout

1. All dimensions in inch [mm]
2. Tolerance :x.xx±0.02 [x.x±0.5]
x.xxx±0.01 [x.xx±0.25]
3. Pin dimension tolerance ±0.004[0.10]

RECOMMENDED PAD LAYOUT

Standard Type Metal Case

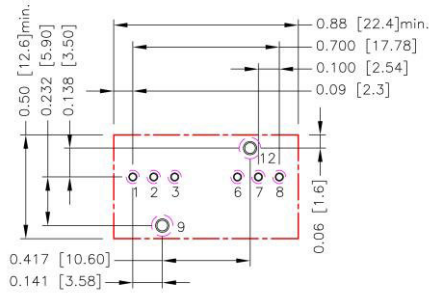

All dimensions in inch[mm]
 Pad size(lead free recommended)
 Through hole 1.2.3.6.7.8: $\Phi 0.031[0.80]$
 Through hole 9.12: $\Phi 0.051[1.30]$
 Top view pad 1.2.3.6.7.8: $\Phi 0.039[1.00]$
 Top view pad 9.12: $\Phi 0.064[1.63]$
 Bottom view pad 1.2.3.6.7.8: $\Phi 0.063[1.60]$
 Bottom view pad 9.12: $\Phi 0.102[2.60]$

Plastic Case

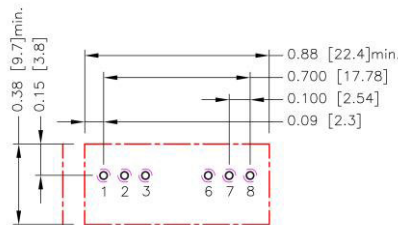

All dimensions in inch[mm]
 Pad size(lead free recommended)
 Through hole 1.2.3.6.7.8: $\Phi 0.031[0.80]$
 Top view pad 1.2.3.6.7.8: $\Phi 0.039[1.00]$
 Bottom view pad 1.2.3.6.7.8: $\Phi 0.063[1.60]$

THERMAL CONSIDERATIONS

The power module operates in a variety of thermal environments. However, sufficient cooling should be provided to help ensure reliable operation of the unit. Heat is removed by conduction, convection, and radiation to the surrounding environment. Proper cooling can be verified by measuring the point as the figure below. The temperature at this location should not exceed “Maximum case temperature”. When operating, adequate cooling must be provided to maintain the test point temperature at or below “Maximum case temperature”. You can limit this temperature to a lower value for extremely high reliability.

- Thermal test condition with vertical direction by natural convection (20LFM).

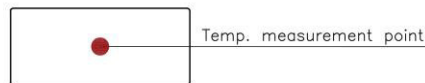

TOP VIEW