

MB91460 – 32-bit MCU series for automotive and industrial applications

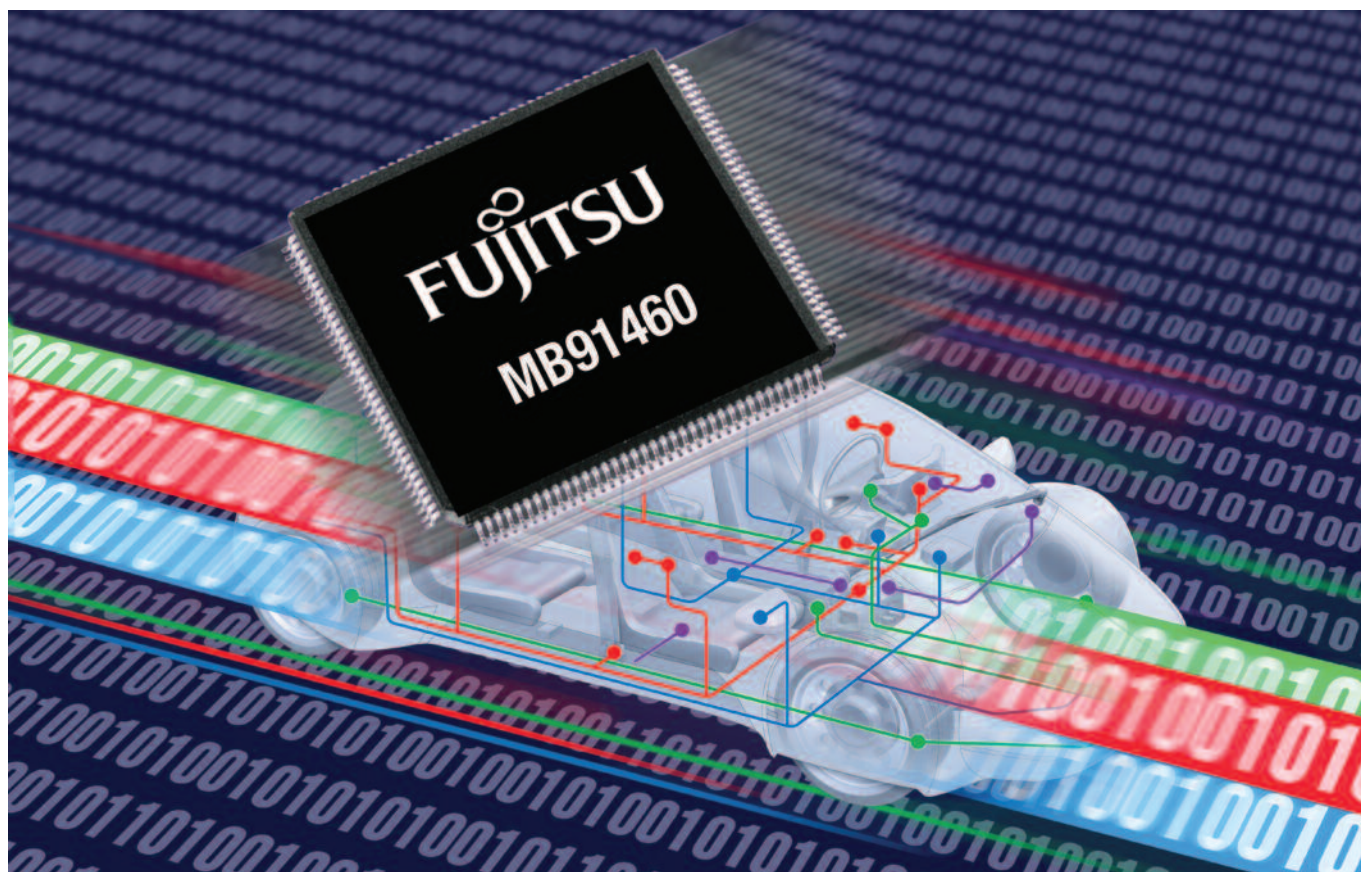

MB91460 is based on a worldwide development effort of design centres in Japan and in Europe (EMDC)

Description

MB91460 is an MCU series based on Fujitsu's FR (Fujitsu RISC) core. This series offers high performance 32-bit MCUs for various applications. The rich feature sets offered by several sub-series allow their application in:

- Automotive
 - Dashboard (also in combination with Fujitsu graphics controllers)
 - Body control
 - Infotainment
 - Chassis
- Industrial
 - Various applications

MB91460 is based on a world wide development effort of design centres in Japan and in Europe (EMDC). For the user it offers a single software platform with a consistent programming model for all devices designed for several application areas including interfaces for nearly all types of automotive networks.

MB91460 uses Fujitsu's well-proven 0.18µm embedded flash technology allowing operating frequencies up to 100MHz. Today there are MB91460 flash MCUs with embedded flash memories between 288kB and 2MB.

Fujitsu's technology offers a minimum of 10,000 write/erase cycles with a data retention time of 20 years. The MCUs are operating from a single voltage between 3.3V and 5V. An on-chip regulator generates the required 1.8V for the internal operation. The standard ambient temperature range is -40 to +105°C. For most MB91460 MCUs operation up to an ambient temperature of 125°C is also possible (please check with Fujitsu).

MB91460 MCUs are lead-free (pure SN pin plating) and are qualified according to AEC-Q100 rules.

FACTSHEET

MB91460 32-BIT MCU SERIES

Features

- FR70 Fujitsu RISC core with 5-stage pipeline operating up to 100MHz
- Up to 2MB embedded flash memory with 64kB and 8kB sectors
- Prefetch/cache architecture to get best possible performance when operating from the internal flash memory
- 'Zero wait cycle' access to on-chip RAM
- EDSU/MPU unit, which can be used for on-chip debugging using e.g. the ACEMIC MDE or as memory protection unit
- BootROM to support initialisation of the MCU and safe reprogramming of even the boot sector in the field
- Clock modulator to significantly reduce EME
- 5-channel DMA with flexible programming of DMA sources
- Proven C-Can (up to 6 channels) and E-Ray FlexRay IP
- High speed 10-bit ADC
- Several voltage domains, which allow optimised separate supply, e.g. 3.3V for the external bus interface.
- Safety features, like
 - Hardware watchdog operating based on the on-chip RC oscillator independent of the main clock
 - Voltage supervision by low voltage detection and alarm comparator
 - Clock supervision based on the on-chip RC oscillator
 - Alarm comparator
 - Flash security
 - BootROM to support safe reprogramming in the field

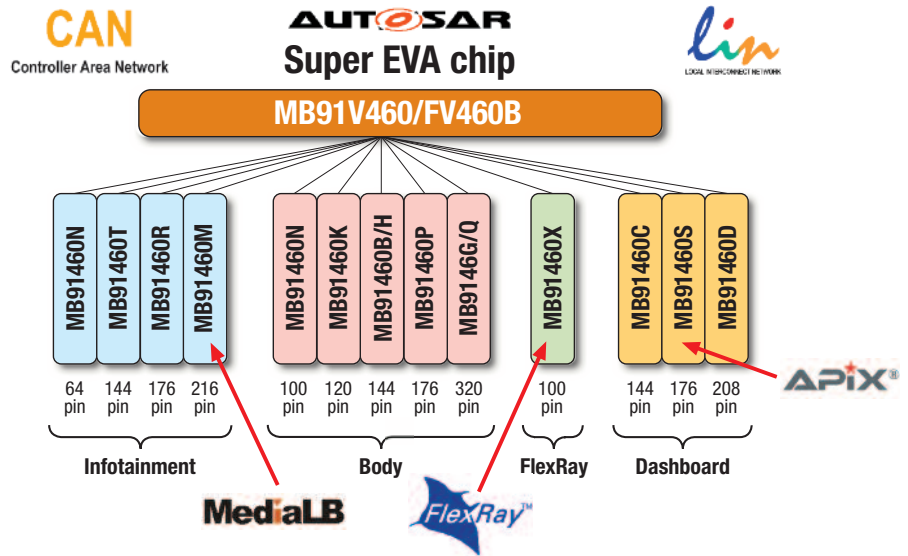

MB91460 sub-series overview

MB91(F)46xyz

Memory Size	Feature Mix/ Pins	Body Gateway	Dashboard	FlexRay	Infotainment	Revision: A-Z First version is always A
■ 1 <160kB	< 100				N	
■ 2 160kB						
■ 3 288kB	100	A, Y		X		
■ 4 416kB	120	K				
■ 5 544kB	144	B, H	C		T	
■ 6 800kB	176	P	S		R	
■ 7 1088kB	208		D			
■ 8 1642kB	216				M	
■ 9 2112kB	256	G, Q				
■ 0 >2112kB						

MB91460 naming conventions

Line-up

The following diagram and tables show an overview across the available MB91460 sub-series and also the naming conventions for MB91460 MCUs. For detailed information please check the MB91460 hardware manual and the related data sheets. Latest information is available on the FSEU webpage at: http://mcu.emea.fujitsu.com/mcu_portal.htm.

All software development can be done on the EVA chip (latest version is MB91FV460B), which is a superset device (for development purposes only) and contains all features available on the mass production devices. See the other chapters below with regard to details for tools and software.

MB91460 Device Overview

	MB91F464A	MB91F465/7B	MB91F463/5/7C	MB91F465/7D	MB91F469G	MB91F464H	MB91F465K
Flash	416kB	544/1088kB	288/544/1088kB	544/1088kB	2112kB	416kB	544kB
Dataflash	-	-	-	-	-	-	-
RAM	16kB	40kB	24/32/64kB	48/64kB	96kB	32kB	16kB
Cache	-	8kB	8kB	8kB	4kB + 16kB	8kB	4kB
CAN	1ch	3ch / 6ch	3	3	6	1	1
LIN-USART	5ch	7ch	5ch	5ch	8ch	7ch	5ch
I ² C	1ch	2ch	3ch	3ch	4ch	2ch	1ch
Other I/F	-	-	-	-	-	-	-
ADC	21ch	32ch	30ch	24ch	32ch	32ch	26ch
SMC	-	-	6	6	-	-	-
PPG	10ch	16ch	12ch	12ch	16ch	16ch	12ch
Reload Timer	8ch	8ch	8ch	8ch	8ch	8ch	8ch
Up/DwnCnt	-	2ch	3ch	3ch	4ch	2ch	-
RTC	yes	yes	yes	yes	yes	yes	yes
ICU/OCU	8ch / 6 ch	8ch / 8ch	8ch / 4ch	8ch / 4ch	8ch / 8ch	8ch / 8ch	8ch / 8ch
Sound Gen	-	yes	yes	yes	yes	yes	-
Ext Bus	-	22A / 16D	-	26A / 32D	28A / 32D	22A / 16D	-
Ext IRQ	10ch	16ch	15ch	14ch	16ch	16ch	10ch
Package	LQFP-100	LQFP-144	LQFP-144	LQFP-208	BGA-320	LQFP-144	LQFP-100

	MB91F467M	MB91F463N	MB91F464/5/7P	MB91F467S	MB91F467R	MB91F467T	MB91F465X
Flash	1088kB	288kB	416/544/1088kB	1088kB	1088kB	1088kB	544kB
Dataflash	-	-	- / - / 64kB	-	-	-	-
RAM	64kB	10kB	40/40/80kB	64kB	40kB	64kB	32kB
Cache	8kB	4kB	8kB	8kB	8kB	8kB	8kB
CAN	2	2	3/3/4	2	2	2	2
LIN-USART	9ch	4ch	12ch	5ch	7ch	11ch	3ch
I ² C	8ch	2ch	4ch	3ch	3ch	4ch	1ch
Other I/F	MLBx1, I2Sx10	-	-	APIX Tx	-	-	FlexRay (A+B)
ADC	12ch	8ch	32ch	16ch	16ch	32ch	17ch
SMC	-	-	-	-	-	-	-
PPG	8ch	8ch	32ch	16ch	8ch	14ch	12ch
Reload Timer	5ch	5ch	16ch	8ch	5ch	8ch	8ch
Up/DwnCnt	-	2ch	4ch	4ch	-	4ch	-
RTC	yes	yes	yes	yes	yes	yes	yes
ICU/OCU	4ch / 4ch	4ch / 4ch	8ch / 8ch	8ch / 4ch	4ch / 4ch	8ch / 8ch	8ch / 6ch
Sound Gen	-	-	yes	yes	-	yes	-
Ext Bus	24A / 16D	-	24A / 16D	24A / 16D	24A / 16D	24A / 16D	-
Ext IRQ	16ch	10ch	16ch	16ch	16ch	12ch	11ch
Package	LQFP-216	LQFP-64	LQFP-176	LQFP-176	LQFP-176	LQFP-144	LQFP-100

FACTSHEET

MB91460 32-BIT MCU SERIES

This page shows block diagrams for two typical MB91460 sub-series. MB91460D for dashboard and MB91460P for body control. Please check the FSEU webpage for block diagrams for all the other devices.

MB91F467D, a member of the **MB91460D sub-series** primarily targets instrumentation, but its rich feature mix also makes it suitable for various other applications.

Features of MB91F467D

- 1088kB of flash memory directly connected to the CPU core via an advanced pre-fetch/caching system. The device includes Fujitsu's flash security feature
- 64kB of RAM
- Stepper motor controller: 6ch
- CAN: 3ch with 32 message buffers each
- LIN-UART: 5ch, (4ch are equipped with transmit and receive FIFOs)
- External bus interface, which supports various memories, but can also be used to connect Fujitsu graphics controllers or the FlexRay ASSP device

A starterkit in two variants (combined with the FlexRay ASSP and without it) is currently available:
SK-91F467D-FLEXRAY or
SK-91F467D-208PFV

Characterising features of the **MB91460P sub-series** are 176 pins, 3-4 CAN channels, 32 channels each of PPGs and ADCs. MB91F467P is also offering on-chip E²PROM emulation via the separate flash module of 64kB (4 x 16kB).

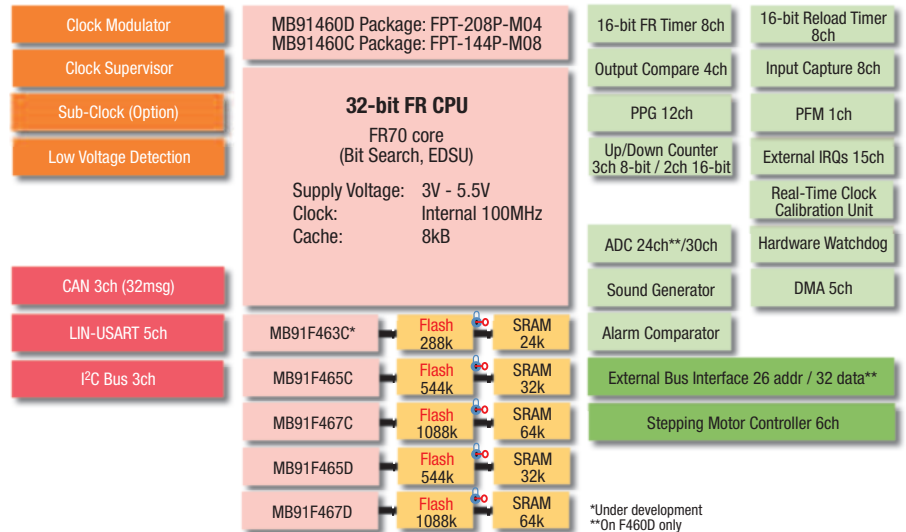

MB91460C / MB91460D series block diagram

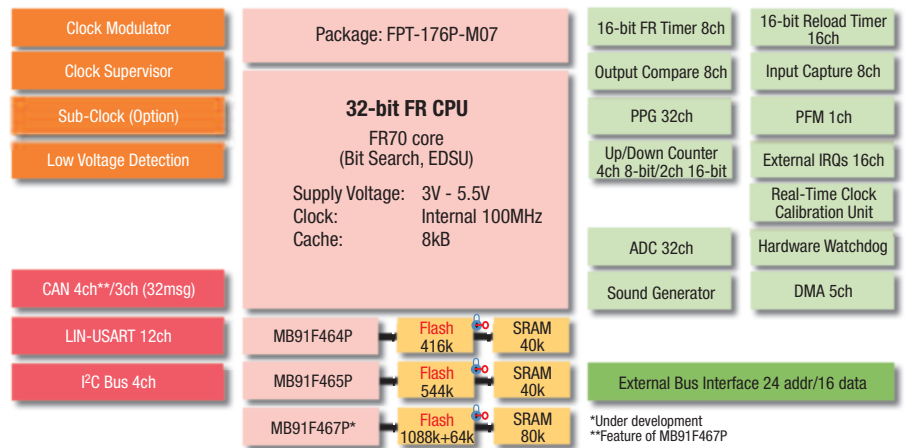

MB91F460P series block diagram

Additional features are:

- LIN-USART: 12ch
- I²C: 4ch
- RTC module, which can operate based on the external 4MHz or 32kHz crystals
- Various timers
- An external bus interface (multiplexed with other function pins) with 24 address and 16 data lines

Software Tools

For the software development for MB91460 MCUs the customer has several options. Support is available for Fujitsu's own development environment called Softune Workbench and for the Green Hills Multi environment. An appropriate on-chip debugging tool is Accemic MDE.

- Softune – Fujitsu's integrated software development package. This package is available for all Fujitsu MCUs from 8 to 32-bit. The Softune Workbench includes:
 - C-Compiler, Macro Assembler, Linker
 - Simulator, Emulator, C checker and analyser
 - Example Projects for all MCU series
 - Freeware flash programming tool via RS232

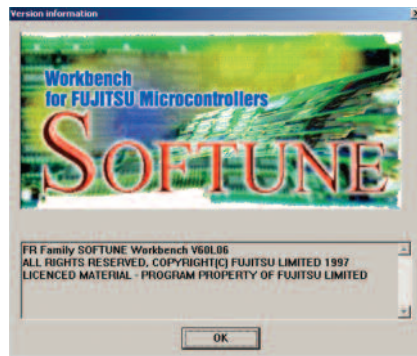

Green Hills

Alternatively the Green Hills Multi environment is supported. The diagram shows the set-up of the related emulation system. The Green Hills product suite, which is supported for MB91460 includes:

- Multi 5 integrated development environment (IDE)
- TimeMachine Tools
- Green Hills compilers (C and C++)
- Super Trace Probe

Key features of Multi 5

- Based on proven debug technology
- Debug the future:
 - MISRA
 - New static analysis - double check
- Debug the present:
 - Run-time error checking
 - Run-time memory checking
- Debug the past:
 - Profiling
 - New improved TimeMachine
- New fast simulator
- New distributed build

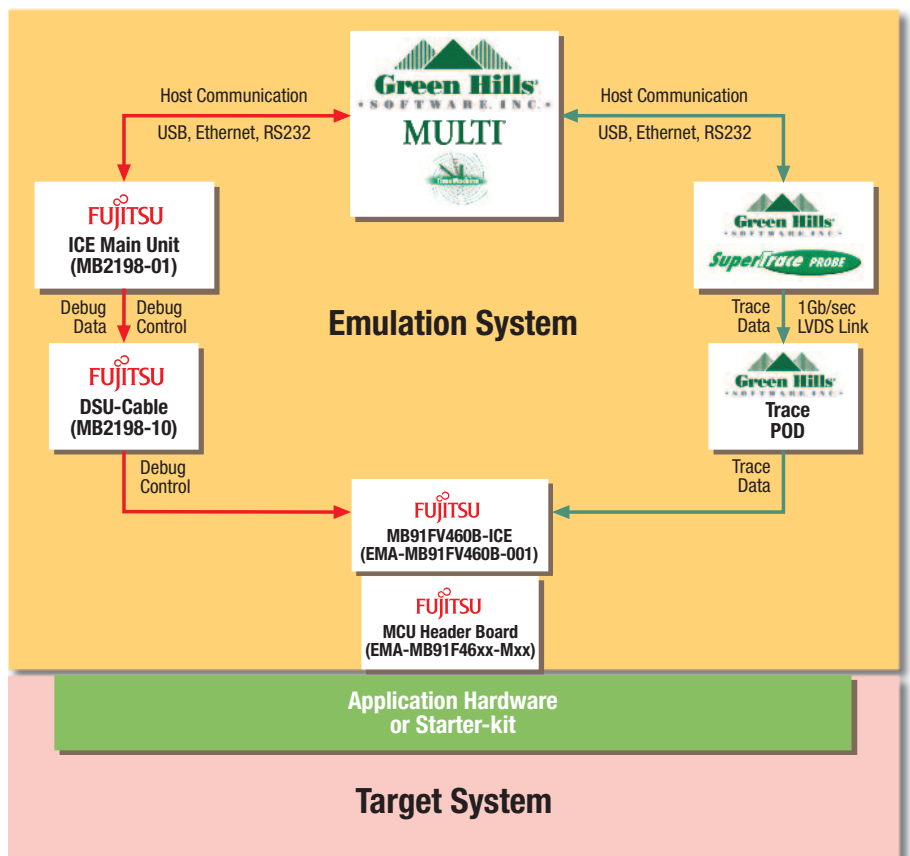

MB91460 development environment with Green Hills Software support

Key features of the Super Trace Probe

- 1 GB standard trace buffer size
- Built on proven Green Hills probe technology
- Tightly integrated with MULTI debugger
- TimeMachine enabled:
 - back-in-time debugging
 - Path analyser, profiling

FACTSHEET MB91460 32-BIT MCU SERIES

Accemic MDE

For on-chip debugging on the flash MCUs, Fujitsu recommends the Accemic MDE (monitor debug environment).

This tool uses the EDSU macro (embedded debug support unit) on the MB91460 flash MCUs.

For both source level and assembly language, Accemic MDE provides all the standard debug functions, including:

- Full source level and symbolic debugging with co-ordinated source and disassembly display
- Execution control: Single Step, Step Into, Step Out and Step Over functions in C and Assembly
- Simple setting of breakpoints in RAM or flash
- Easy identification of program elements through colour highlighted source code keywords and comments
- Variable displays with type and address information
- Drag-and-drop values into variables to modify values
- Watch windows for local and global variables
- Views of all memory areas, registers and disassembled program
- Colour highlighting of recently changed data
- Integrated flash programming utilities to download a program from the host PC
- Online and context-sensitive help

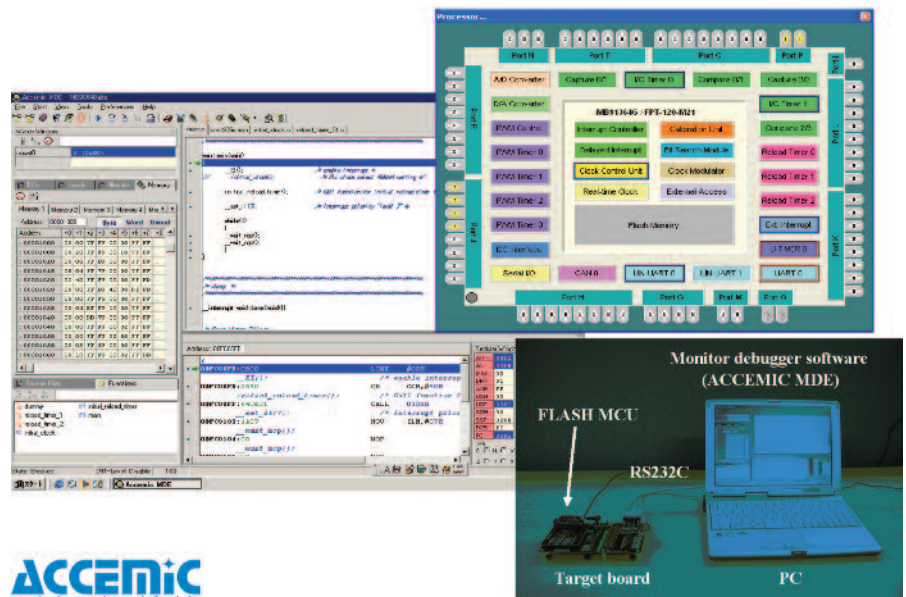

Accemic GmbH & Co. KG
Hochriesstr. 2
83126 Flintsbach
Germany
Tel: +49 8034 90993-0
Fax: +49 8034 90993-27
Email: info@accemic.com
Web: www.accemic.com

Features usually found only in high-end tools...

- Complete and extensive processor visualisation
- Easy access to any C object including enums, bit fields, structs, arrays and floats
- Transmit messages and variables from running applications to the PC
- Call function and interrupt service routines
- RTOS awareness

Hardware tools

For each MB91406 MCU, Fujitsu also offers the required hardware tools. This includes the necessary emulation system either for Softune or for the Green Hills tool suite. These hardware tools typically consist of:

- Evaluation system
 - Emulator (MB2198-01-E)
 - DSU cable (MB2198-10-E)
 - Adapter board (EMA-MB91V460A-002B or successor)
 - Socket adapter board (for MB91F467D this is e.g. EMA-MB91F467D-NLS-208M04)
- Starterkits
 - Evaluation board (for MB91F467D this is e.g. SK-91F467D-208PFV).
- Flash programmer
 - This is usually available via a third party company in Europe or often also in Japan. Please contact Fujitsu for details or check the web page for third-party offerings

- Emulator (MB2198-01-E)
- DSU cable (MB2198-10-E)
- Adapter board (EMA-MB91FV460B-001)
- Socket adapter board (EMA-MB91F467D-NLS-208M04)
- Evaluation board (SK-91F467D-208PFV)

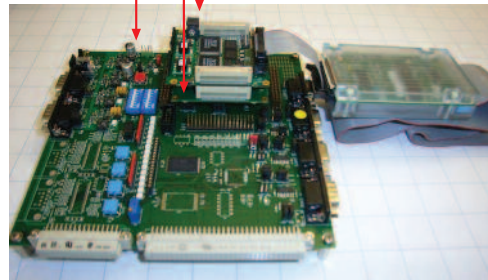

MB91460 Fujitsu's emulation system

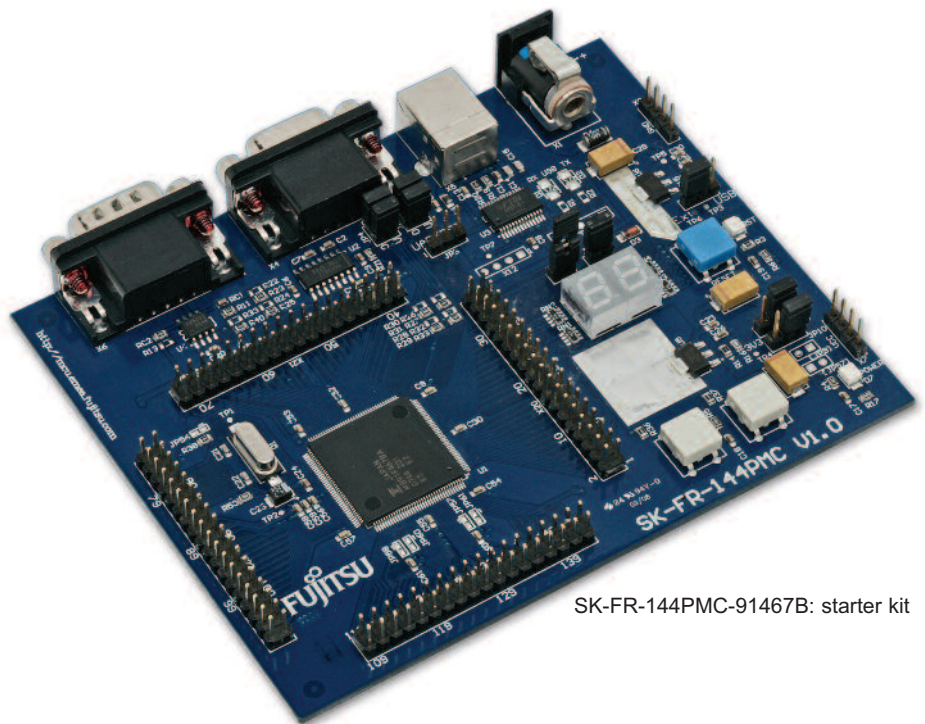

SK-FR-144PMC-91467B: starter kit

FACTSHEET MB91460 32-BIT MCU SERIES

Together with various partners Fujitsu has developed the required software eco system for the MB91460 series.

Please see the table for an overview over some available software modules. More information can again be found on the Fujitsu webpage.

The diagram summarises the available support environments.

Software and Services

- The focus shift from hardware to software will continue
- Fujitsu is supporting this by closely co-operating with several software partners to develop drivers and operating systems according to the latest standards

Fujitsu is building internal resources to offer additional software products and services

- Software product development
 - e.g. flash E²PROM-emulation-driver
 - e.g. special drivers not covered by AUTOSAR specification
- Software consulting services
 - Support for integration
 - Support for software porting
- Software maintenance

Software and related services will be handled as a product

- Fujitsu will take care of the development of required low level drivers and AUTOSAR MCAL
- Fujitsu will sell this software (various licence models) to its customers

MB91460 available software

Software	Supplier	Availability
LIN 2.0 (master/slave)	Elektrobit	Available
CAN-driver	Vector Informatik	Available
FlexRay	Elektrobit	Available
HIS-flash	Elektrobit	Available
HIS SPI E ² PROM driver	Elektrobit	Available
HIS I/O (DIO, ADC, PWM, WDT)	Elektrobit	Available
ProOSEK /osCAN	Elektrobit Vector Informatik	Available
ProOSEK/time	Elektrobit	Available
AUTOSAR (complete package)	Elektrobit	Available
FreeRTOS™	Wittenstein High Integrity Systems	Available

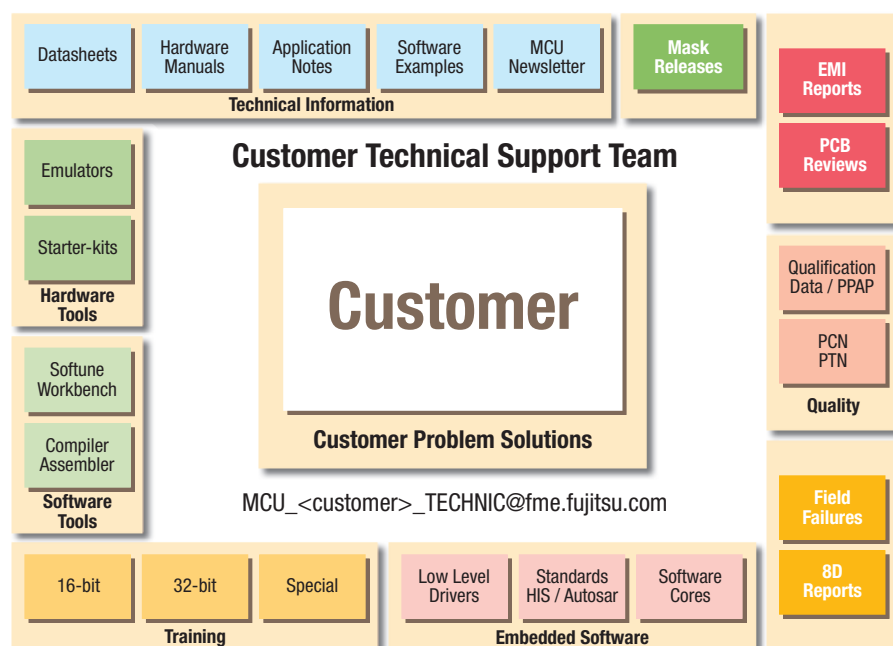

ASK FUJITSU SEMICONDUCTOR EUROPE

Contact us on +49(0) 61 03 69 00 or visit
<http://emea.fujitsu.com/semiconductor>